



JPSOLUTIONS®

Catálogo **2021**

Produtos e Soluções

Norma de Desempenho NBR15575

www.jps.ind.br



JPSOLUTIONS®

SHAFT MODULAR® 80

JPSM01 - ARTEFATO DE CIMENTO

2021

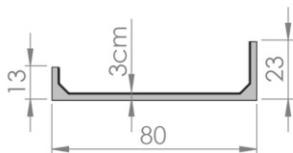

VISTA SUPERIOR



VISTA FRONTAL

INFORMAÇÕES TÉCNICAS

PESO: 13 kg

ESPESSURA: 3cm

ALTURA: 19 cm

COMPRIMENTO: 80cm

LARGURA 01: 13cm

MEDIDAS DO PALETE DE TRANSPORTE: 1,17 x 0,87cm

LARGURA 02: 23cm

PEÇAS POR PALETE: 60

APLICAÇÕES DO PRODUTO

- SHAFT DE BANHEIRO

- QUADRO ELÉTRICO

- SHAFT TÉCNICO

SHAFT MODULAR® 80 X 23 X 19

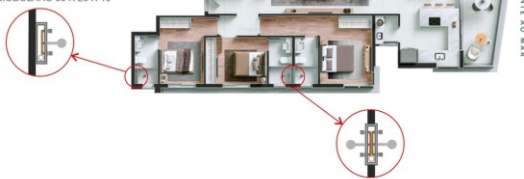

SHAFT MODULAR® ESPELHADO 80 X 23 X 19

www.jps.ind.br

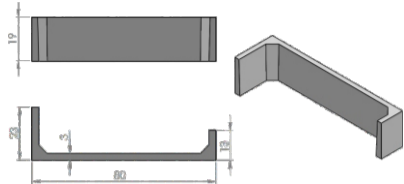

JPSM01 - Shaft Modular® 80 (80 x 23/13 x 19)

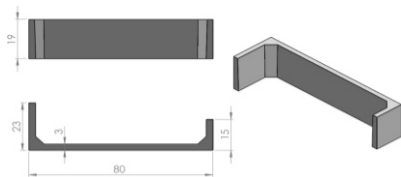

JPSM07 - Shaft Modular® 80 (80 x 23/15 x 19)

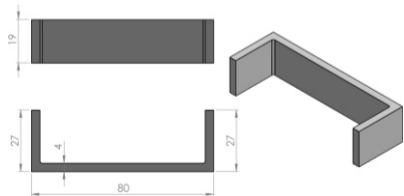

JPSM05 - Shaft Modular® 80 (80 x 27 x 19)

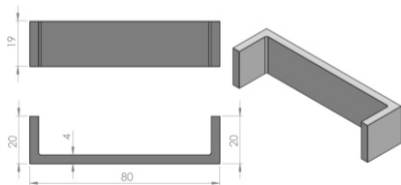

JPSM04 - Shaft Modular® 80 (80 x 20 x 19)



JPSOLUTIONS®

SHAFT MODULAR® 60

JPSM03 - ARTEFATO DE CIMENTO

2021

SHAFT
MODULAR 60®

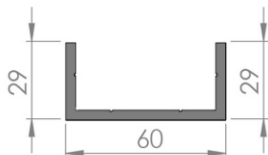

VISTA SUPERIOR



VISTA FRONTAL

INFORMAÇÕES TÉCNICAS

PESO: 15 kg

ESPESSURA: 3cm

ALTURA: 19 cm

COMPRIMENTO: 60cm

LARGURA 01: 29cm

MEDIDAS DO PALETE DE TRANSPORTE: 1,17 x 0,87cm

LARGURA 02: 29cm

PEÇAS POR PALETE: 56

APLICAÇÕES DO PRODUTO

- SHAFT DE LAVANDERIA

- DUTOS CHURRASQUEIRA

- DUTOS DE EXAUSTÃO

EXAUSTÃO DA CHURRASQUEIRA



SHAFT MODULAR® ÁREA DE SERVIÇO

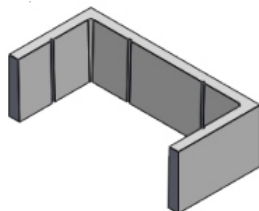
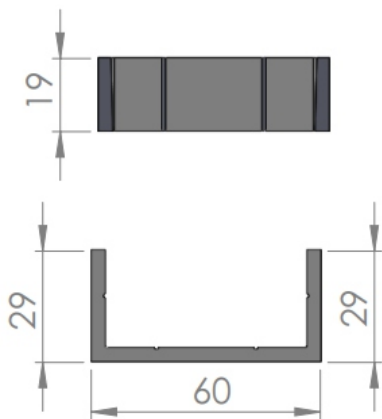

JPSM03 - Shaft Modular® 60 (60 x 29 x 19)

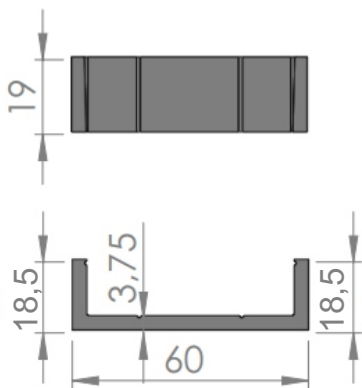

JPSM03 - Shaft Modular® 60 (60 x 18,5 x 19)



JPSOLUTIONS®

SHAFT MODULAR® LIGHT

JPSM02 - ARTEFATO DE CIMENTO

2021



VISTA SUPERIOR



VISTA FRONTAL

INFORMAÇÕES TÉCNICAS

PESO: 10,6 kg

ESPESSURA: 3cm

ALTURA: 19 cm

MEDIDAS DO PALETE DE TRANSPORTE: 1,17 x 0,87cm

LARGURA: 7 cm

PEÇAS POR PALETE: 96

COMPRIMENTO: 80cm

APLICAÇÕES DO PRODUTO

- ACABAMENTO EM PAREDE - EMBOÇO DE COLUNA - SHAFT ESPELHADO EM BANHEIRO





JPSOLUCIONS®

DUTO MODULAR

JPDCH01 - ARTEFATO DE CIMENTO

2021

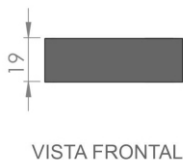
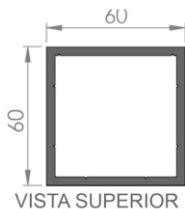

INFORMAÇÕES TÉCNICAS

PESO: 30 kg

COMPRIMENTO: 60cm

ALTURA: 19 cm

MEDIDAS DO PALETE DE TRANSPORTE: 1,17 x 0,87cm

LARGURA: 60 cm

PEÇAS POR PALETE: 13

APLICAÇÕES DO PRODUTO

- DUTO DE AR - BOCA DE LOBO - COCHO PARA COLUNA - ESTRUTURA PARA KIT GÁS





SHAFT MODULAR MULTIUSO

SHAFT MODULAR® MULTIUSO

JPBM01 - ARTEFATO DE CIMENTO

2021

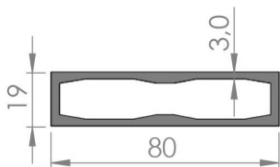

VISTA SUPERIOR



VISTA FRONTAL

INFORMAÇÕES TÉCNICAS

PESO: 25 kg

ESPESSURA: 3cm

ALTURA: 19 cm

MEDIDAS DO PALETE DE TRANSPORTE: 1,17 x 0,87cm

LARGURA: 19 cm

PEÇAS POR PALETE: 36

COMPRIMENTO: 80cm

APLICAÇÕES DO PRODUTO

- DIVISÃO DE AMBIENTE - VIGA PRUMO - LIGAÇÃO DE PASSAGEM LAJE - SHAFT TÉCNICO





JPSOLUÇÕES®

CHURRASQUEIRA MODULAR

JPCM01 - ARTEFATO DE CIMENTO

2021

1ª ETAPA

Nivele e apreme corretamente a primeira peça da Churrasqueira Modular®, para que a continuidade seja perfeita;
Inicie a sobreposição das peças(Item 1), sempre conferindo prumo e nível, e com uma régua confira o alinhamento perfeito da prumada toda;

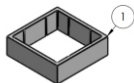

2ª ETAPA

Fixe a base da churrasqueira e logo após instale as próximas duas peças da Churrasqueira Modular® formando o braseiro da churrasqueira

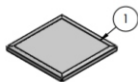

3ª ETAPA

Faça um recorte na peça seguindo a marcação já encontrada na mesma, repita esta etapa 1x(2 peças no total) item 3; Faça na próxima peça um recorte, terminando a abertura da churrasqueira com 55cm(Item 4)

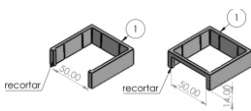

5ª ETAPA

Faça um recorte na peça seguindo a marcação já encontrada na mesma(27cm), recorte necessária para a passagem da fumaça(Item 5); Logo em seguida faça a instalação do Dumper(Item 7);

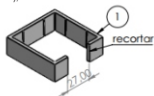

4ª ETAPA

Instale e fixe a as proximas 2(duas) peças(Item 1);

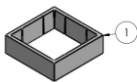

6ª ETAPA

Termine a instalação das ultimas peças até a altura desejada(Item 1);

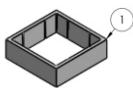

INFORMAÇÕES TÉCNICAS

PESO: 450 à 650 kg

COMPRIMENTO: 60cm

ALTURA: 2,60 à 3,00 mt

MEDIDAS DO PALETE DE TRANSPORTE: 1,17 x 0,87cm

LARGURA: 60 cm ou 80 cm



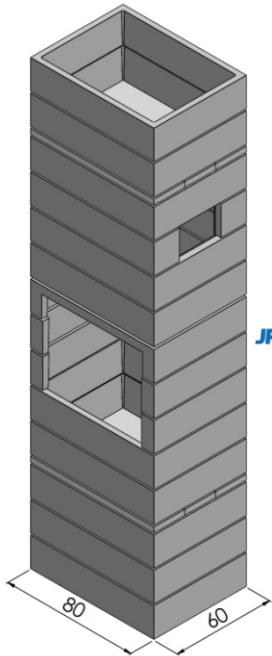

JPCM8001 - Churrasqueira
Modular® 80x60



JPSOLUCIONS®

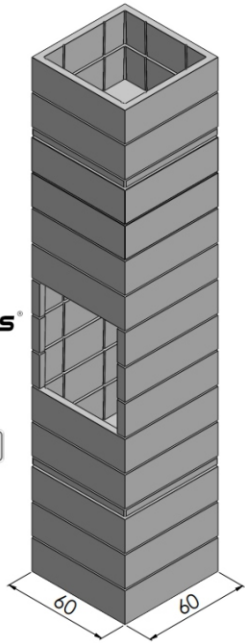

JPCM6001 - Churrasqueira
Modular® 60x60



JPSOLUTIONS®
BLOCO COMPENSADOR 9
JPCP01 - ARTEFATO DE CIMENTO
2021

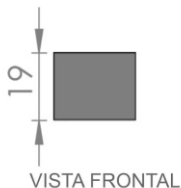
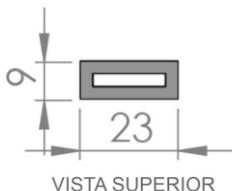

INFORMAÇÕES TÉCNICAS

PESO: 6 kg

ESPESSURA: 3cm

ALTURA: 19 cm

MEDIDAS DO PALETE DE TRANSPORTE: 1,17 x 0,87cm

LARGURA: 9 cm

PEÇAS POR PALETE: 264

COMPRIMENTO: 23cm





JPSOLUTIONS®

BLOCO COMPENSADOR 19

JPCPO2 - ARTEFATO DE CIMENTO

2021

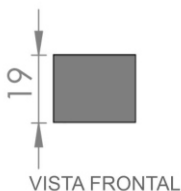
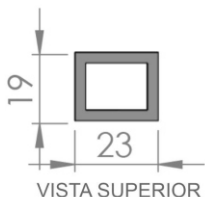

INFORMAÇÕES TÉCNICAS

PESO: 8 kg

ESPESSURA: 3cm

ALTURA: 19 cm

MEDIDAS DO PALETE DE TRANSPORTE: 1,17 x 0,87cm

LARGURA: 19 cm

PEÇAS POR PALETE: 132

COMPRIMENTO: 23cm

APLICAÇÕES DO PRODUTO

- COMPENSAÇÃO DE MEDIDA - SHAFT TÉCNICO - MUROS - COLUNA ESTRUTURAL





JPSOLUTIONS®

PLACA MODULAR

JPPCH01 - ARTEFATO DE CIMENTO

2021

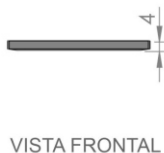
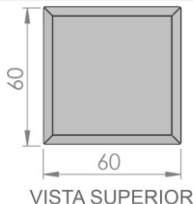

INFORMAÇÕES TÉCNICAS

PESO: 35 kg

COMPRIMENTO: 60cm

ALTURA: 4 cm

MEDIDAS DO PALETE DE TRANSPORTE: 1,17 x 0,87cm

LARGURA: 60 cm

PEÇAS POR PALETE: 100

APLICAÇÕES DO PRODUTO

- BASE CHURRASQUEIRA - PISANTE - USOS DIVERSOS





JPSOLUTIONS[®]



@jps.ind.br



contato@jps.ind.br



47 99990-2900

www.jps.ind.br